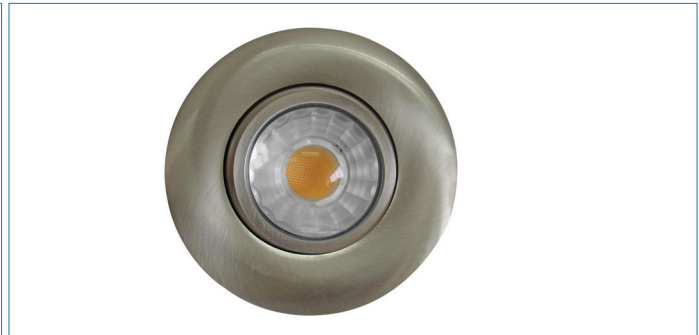
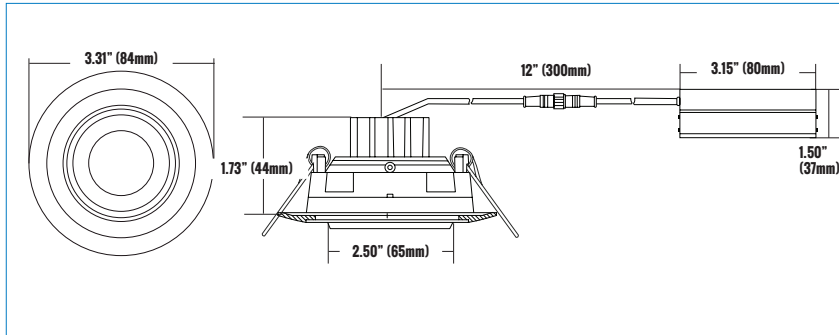

CATALOG #		TYPE
PROJECT		DATE
PREPARED BY		

PRODUCT CODE: DLSGR3-814WD-BN
3 INCH LED SLIM GIMBAL DOWN LIGHT

PRODUCT DESCRIPTION

The Etlin-Daniels DLSGR3-814WD-BN LED 3 inch Slim Gimbal Recessed Downlight offers a modern, energy-efficient solution for retrofitting existing incandescent & halogen recessed fixtures, as well as for new construction. Requiring only a 2-3/4" round hole, and with the driver inside a compact connection box (does not require an external j-box) the DLSG series is simple to install and is both IC rated and Airtight. The 38° beam with 30° tilt and 360° rotation is perfect for sloped ceilings or to highlight artwork. Triac dimmer compatible with Warm Dim feature - 3000K dims down to 2200K // 4000K dims down to 3000K. Available in round and square face in white, brushed nickel and black trim. 6W version supplies 420lm (FMW equivalent) and 8W version supplies 600lm (EXN compatible).

FEATURES

- LED Indoor Light Source.
- 3" Gimbal Recessed Downlight.
- Durable die-cast aluminum alloy for optimal heat dissipation.
- Scratch resistant, smooth finish.
- Unique gimbal design with 30° tilt and 360° rotation.
- Type IC and Airtight, Damp location rated.
- Ceiling clearance required: 2-1/2" for Romex, 3-1/2" for MC or BX installations.
- Triac Warm Dim down to 10%.
- Warm Dim - 3000K dims to 2200K // 4000K dims to 3000K.
- Guaranteed 98% Lumen Maintenance after 6,000 hour life.
- Round and square housings available in white, black and brushed nickel.
- 5 year warranty
- L70 - 50,000 hours
- Energy Star certified.

PRODUCT SPECIFICATIONS (OPTICAL DATA)

PRODUCT SPECIFICATIONS (ELECTRICAL DATA)

LED TYPE	LED QTY	SYSTEM EFFICACY	LUMENS	COLOR TEMPERATURE	BEAM ANGLE	CRI	SYSTEM EFFICIENCY	VOLTAGE	POWER FREQ.	POWER FACTOR
COB	1 CHIP	75LM/W	600LM	4000K-3000K	38°	>80CRI	>82%	AC120V	50-60HZ	>0.90

PRODUCT SPECIFICATIONS

WATTAGE	FIXTURE MATERIAL	LIFE SPAN	STORAGE TEMP	OPERATING TEMP	PRODUCT DIMENSIONS	CARTON SIZE	
8W	ACRYLIC LENS/ ALUMINUM BODY	>50,000 HOURS	-20°C~-40C -4°F~-104°F	-20°C~-40°C -4°F~-104°F	3.31 X 1.73 INCHES (84 X 44 MM)	14.76 X 9.25 X 12.20 INCHES (375 X 235 X 310MM)	

ADDITIONAL INFORMATION

INSTALLATION METHOD

RECESSED CEILING MOUNT

FIXTURE COLOR

BRUSHED NICKEL

CONTROL TYPE

WARM DIM TRIAC

CATALOG #		TYPE
PROJECT		DATE
PREPARED BY		

PRODUCT CODE: DLSGR3-814WD-BN 3 INCH LED SLIM GIMBAL DOWN LIGHT

LUMINAIRE PHOTOMETRIC (TEST REPORT)

ILLUMINANCE (AT A DISTANCE) FLUX OUT: 462.3LM

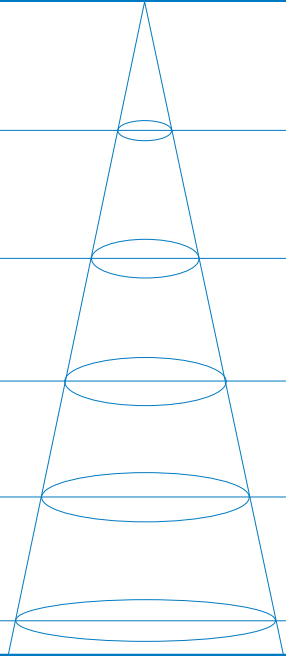
3.28FT 1M	75.87,112.8FC 816.7,1214LX		2.766FT 84.29CM
6.56FT 2M	18.97,28.20FC 204.2,303.5LX		5.531FT 168.59CM
9.84FT 3M	8.430,12.53FC 90.74,134.9LX		8.297FT 252.88CM
13.12FT 4M	4.742,7.050FC 51.04, 75.88LX		11.06FT 337.18CM
16.4FT 5M	3.035, 4.512FC 32.67, 48.56LX		13.83FT 421.47CM
HT	EAVG/EMAX	ANGLE: 45.71DEG	DIA

LUMINOUS INTENSITY DISTRIBUTION DIAGRAM

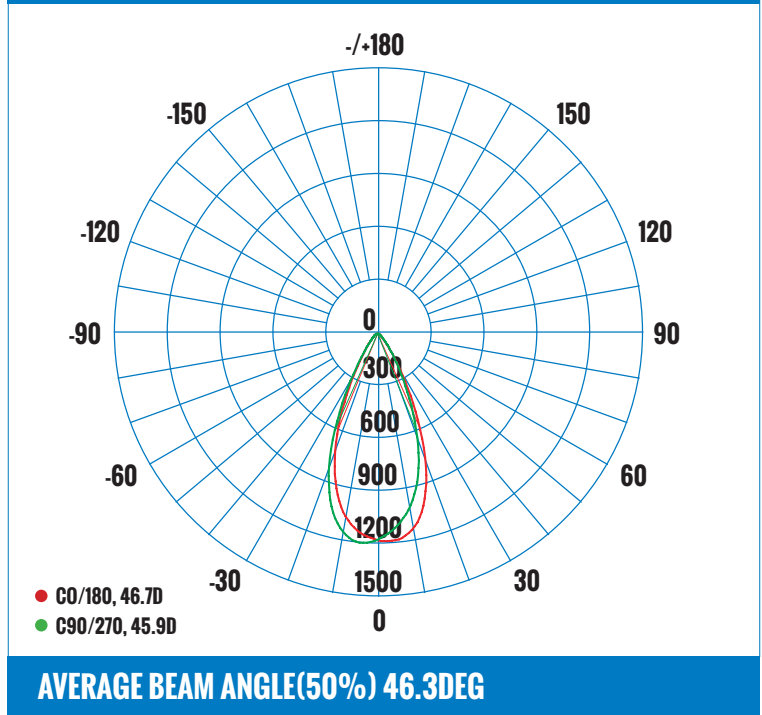

CERTIFICATIONS







DRIVER/LED CHIP



120V APPROVED DIMMERS

LUTRON: CTCL-153PDH · CTCL-153P
CT-600P · DVCL-153P
LEVITON: 6672 · 6674
COOPER: HCL453PTCCCV6

ACCESSORIES

 GOOF RING, OD 4 1/2" PART# DLSGR3-GR3	 ROUGH-IN PLATE PART# DLSGR3-RIP3	 72" EXTENSION CORD PART# DLSGR3-EC72	 240" EXTENSION CORD PART# DLSGR3-EC240
--	--	--	--

ORDERING INFORMATION - DLSGR SERIES

SERIES	SHAPE	SIZE	WATTAGE	VOLTAGE	COLOR TEMPERATURE	DIMMABLE	COLOR
E.G. DLSG	R	3	8	1	4	WD	BN
DLSG - DOWN LIGHT	R - ROUND	3"	8 - 8W	1 - 120V	4 - 4000K-3000K	WD - WARM DIM	WH - WHITE
SLIM GIMBAL							BL - BLACK
							BN - BRUSHED NICKEL

Head Office - 1850 Wilson Ave. · Toronto, ON · M9M 1A1 · Tel: 416.741.7336 · Fax: 416.741.9104

Toll Free: in Canada. 1.800.661.9610 · in USA. 1.888.762.5384 (SOCKETS4U)

www.etlin-daniels.com · For sales/service questions · sales@etlin.com